

ELEMENTY ZE SKLEJKI

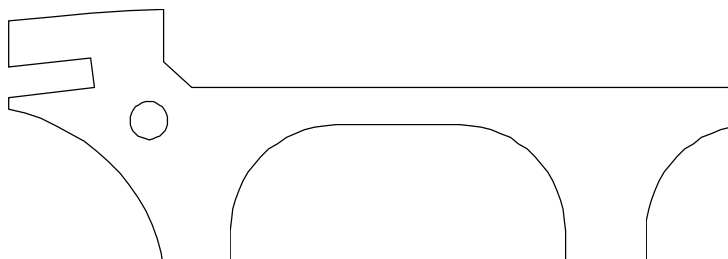

SD 7037

1,5 mm

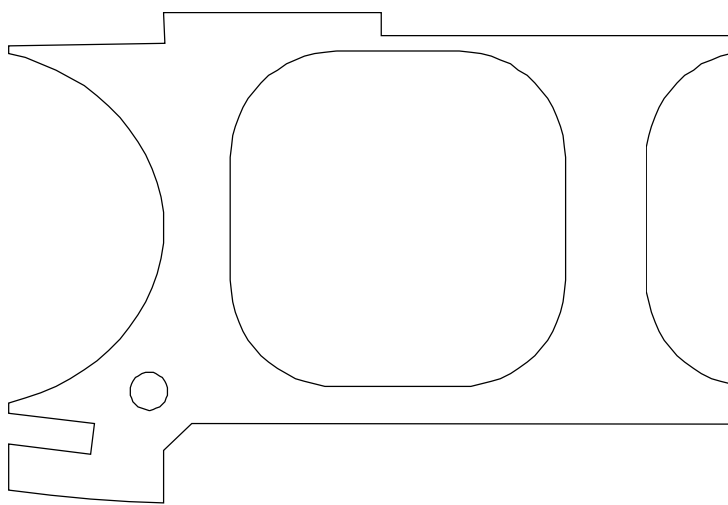
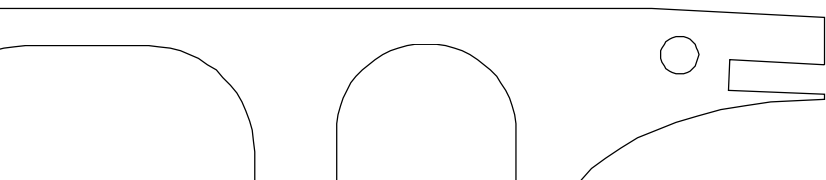
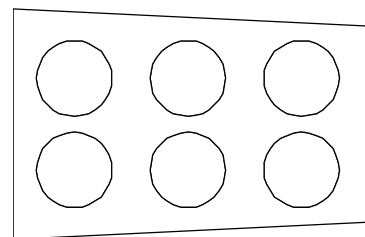
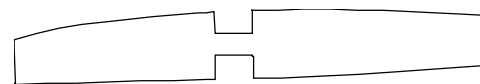
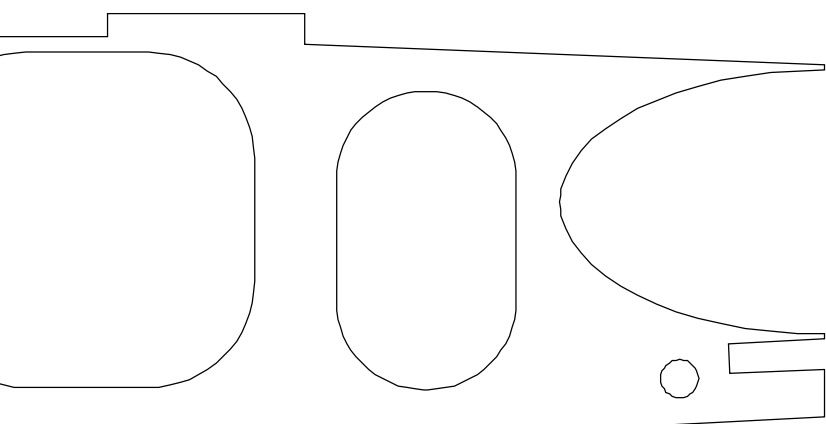

WYCIĄĆ Z

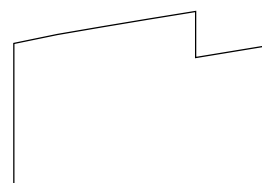
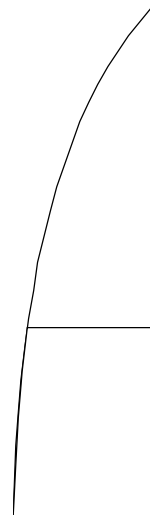
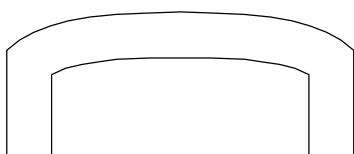
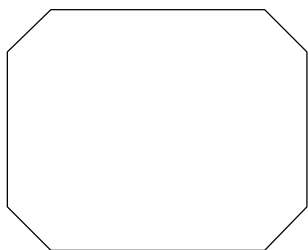
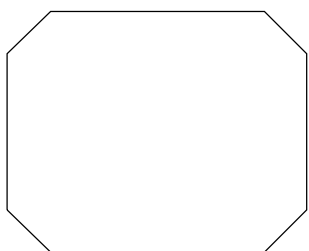
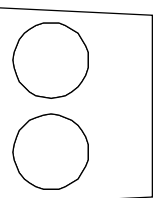
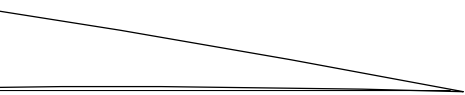

DEPRONU 6 mm

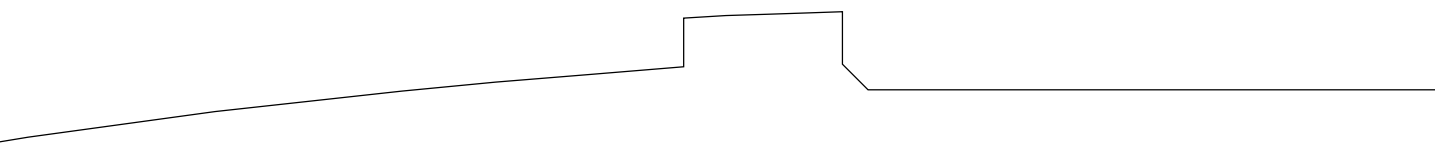
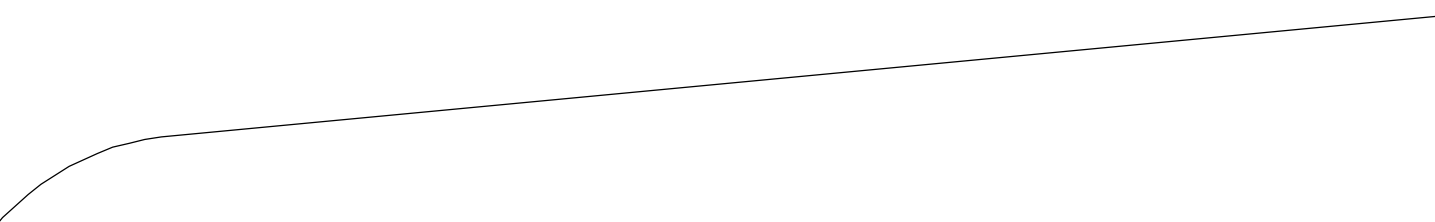

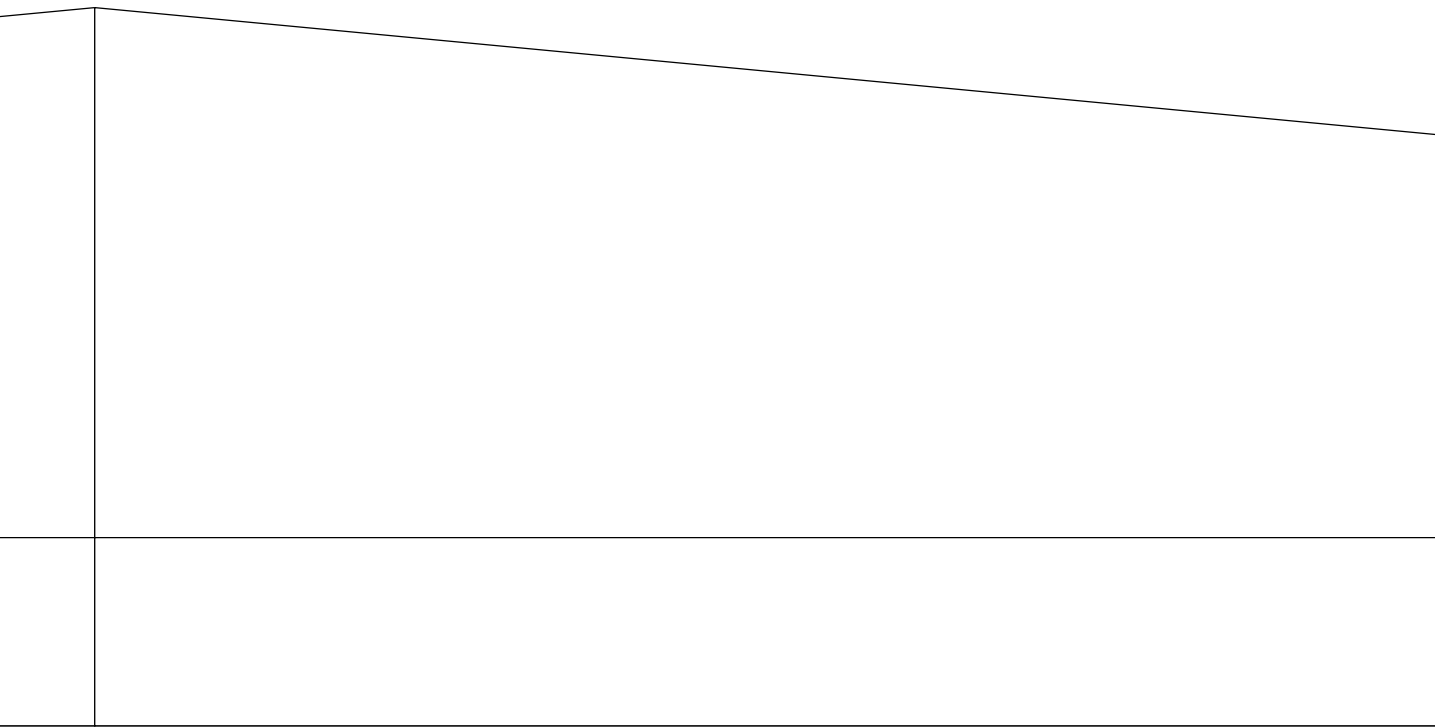
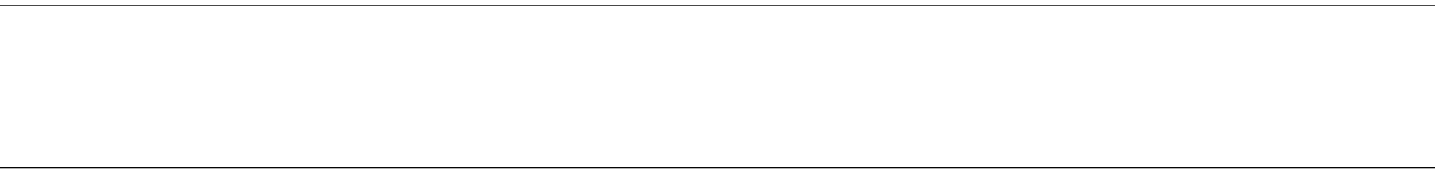

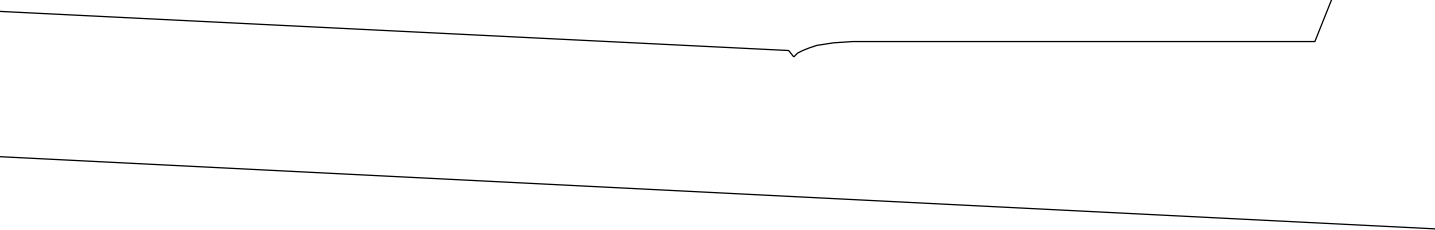
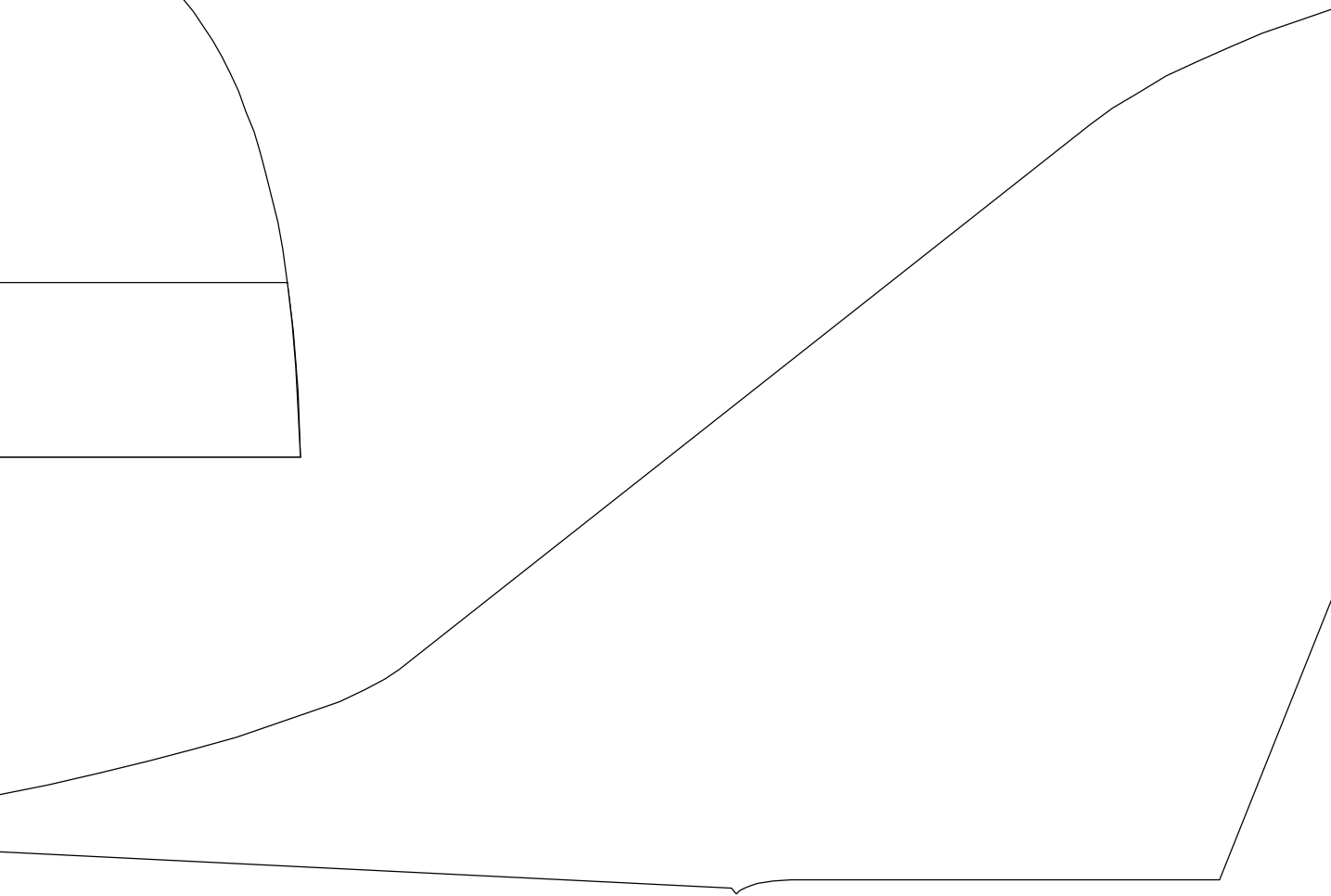
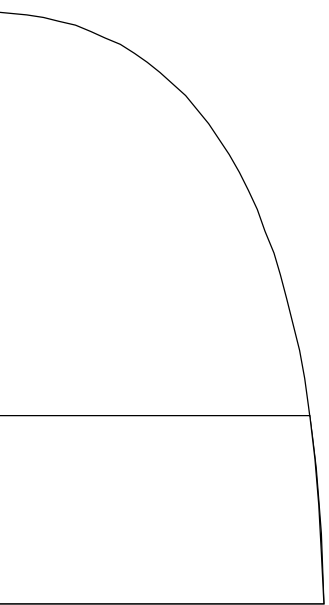

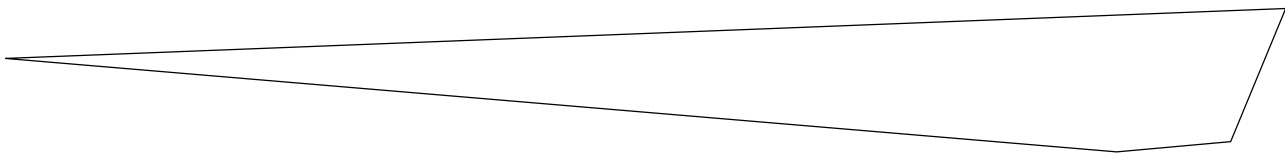
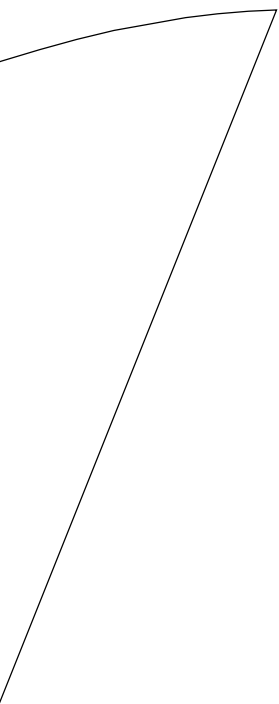
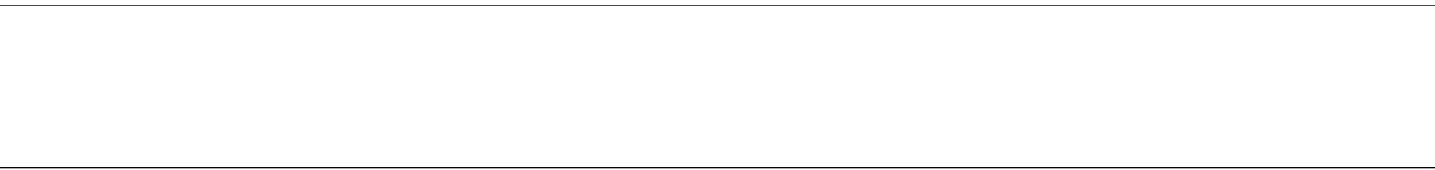

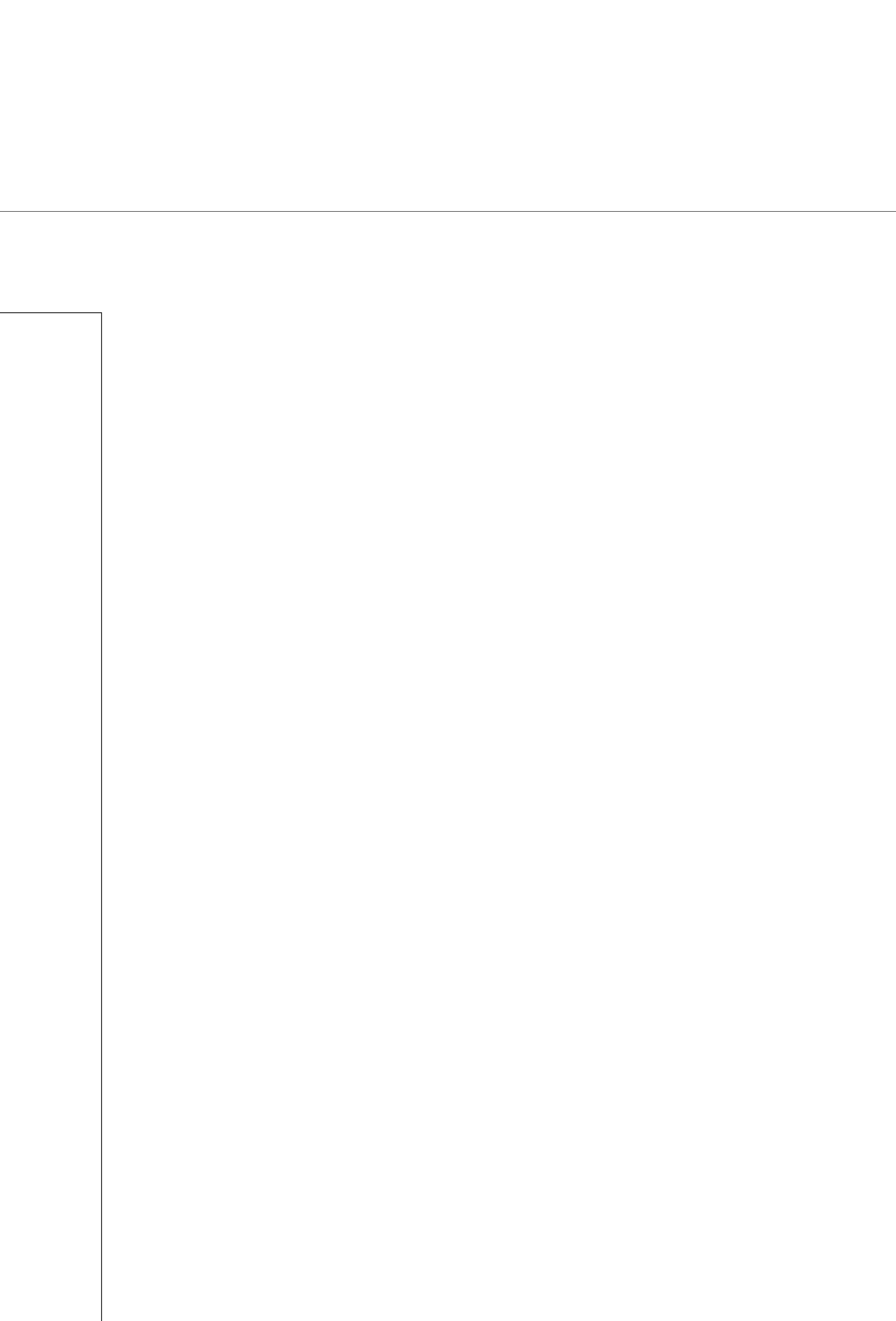

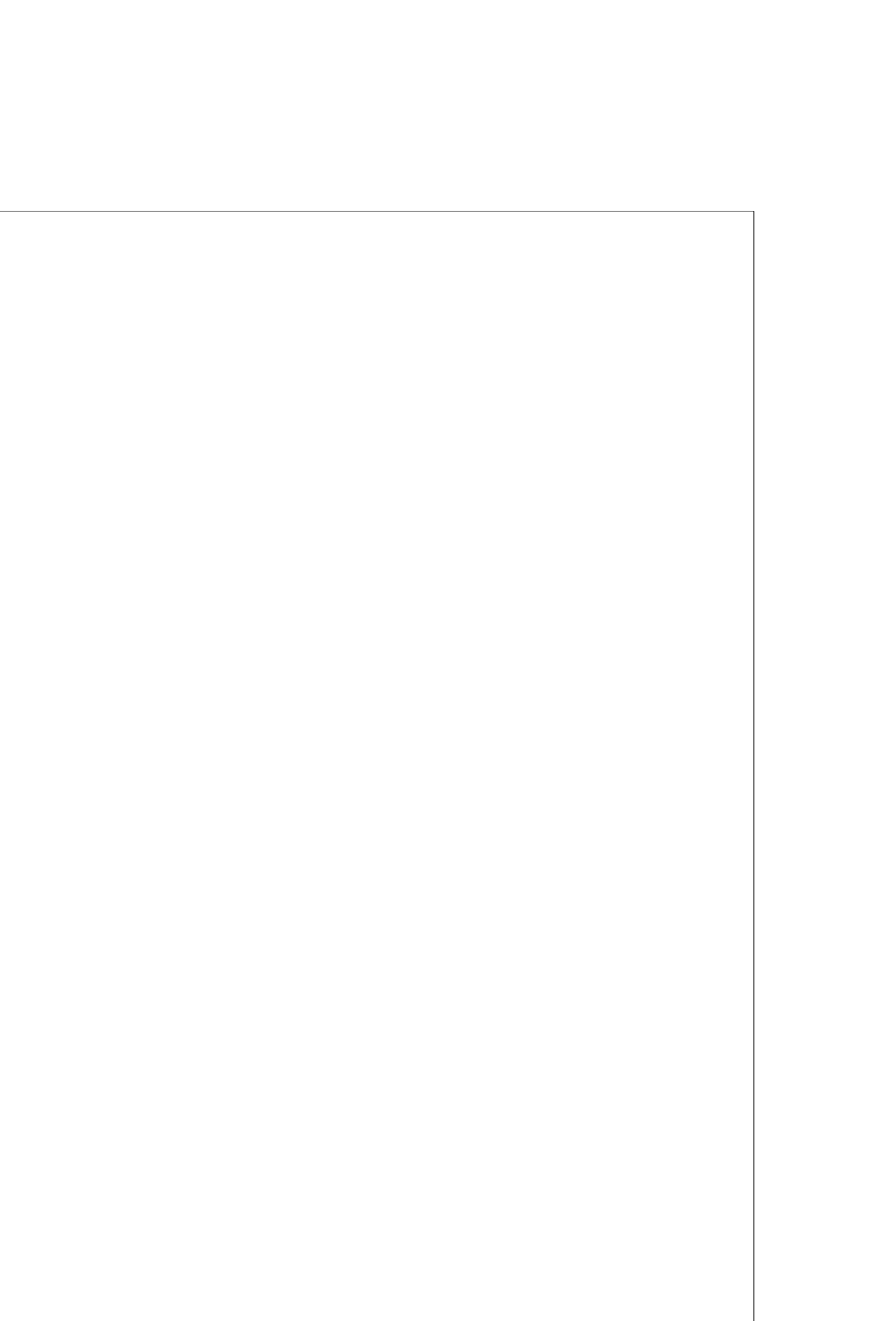

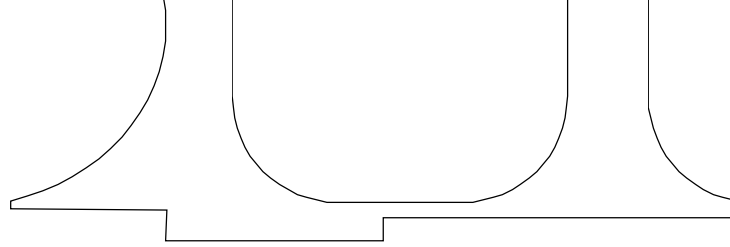

ELEMENTY ZE SKLEJKI

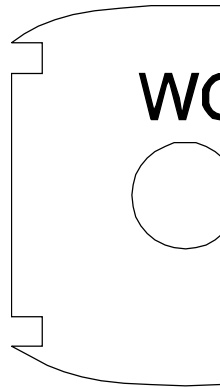
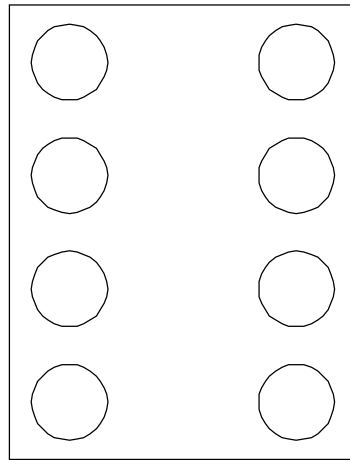

OSŁONA SERWA - KOMPL WYDRUKOWAĆ ZE ZWYK

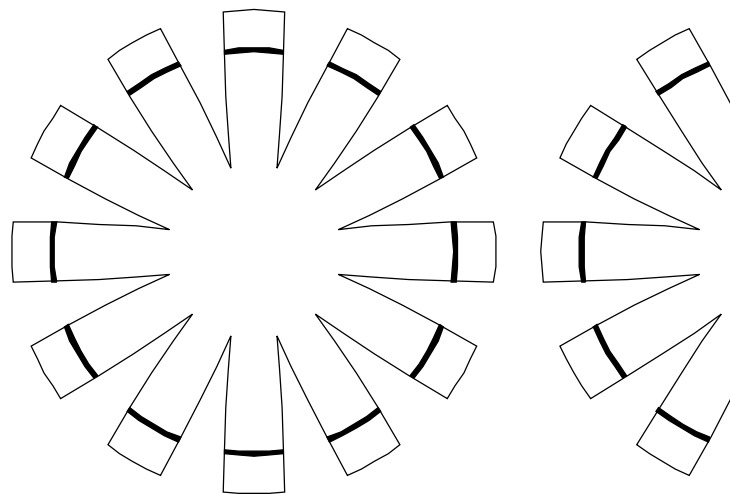

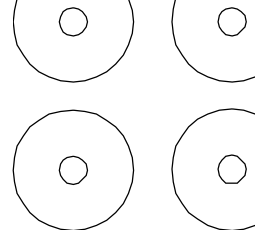
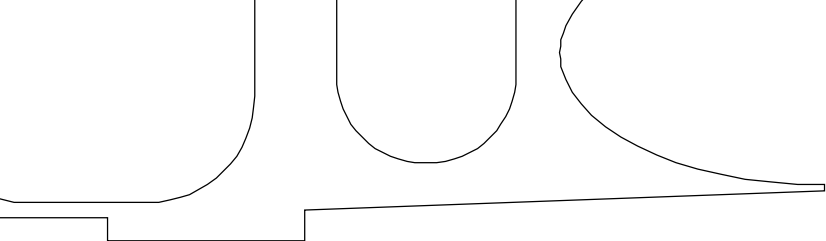

3 mm (lub 2 x 1,5 mm)

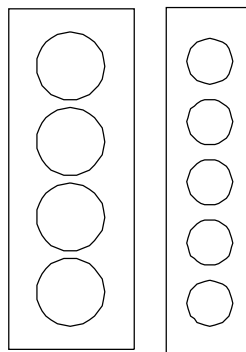

LET NA 1 SZTUKĘ
ŁĘGO PAPIERU.

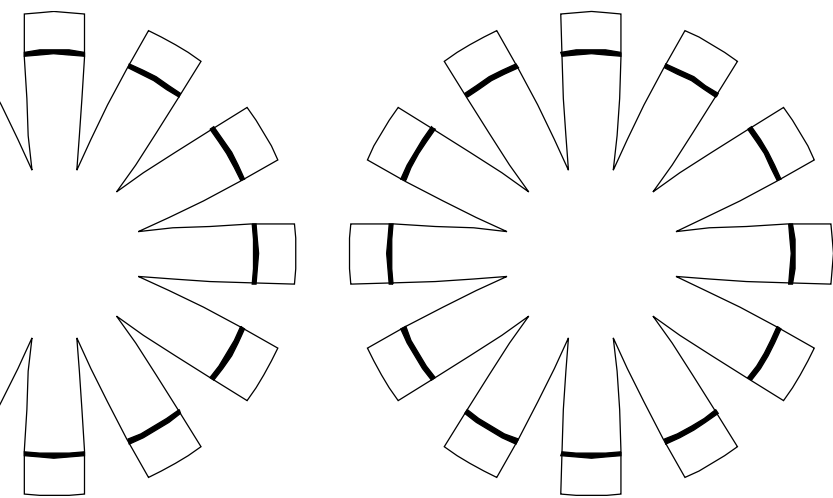

JAK UZYSKA

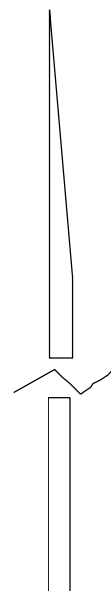

W2

W1

Ć PROFIL

Taśma klejąca

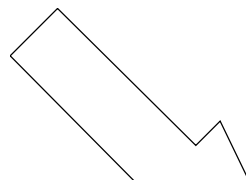

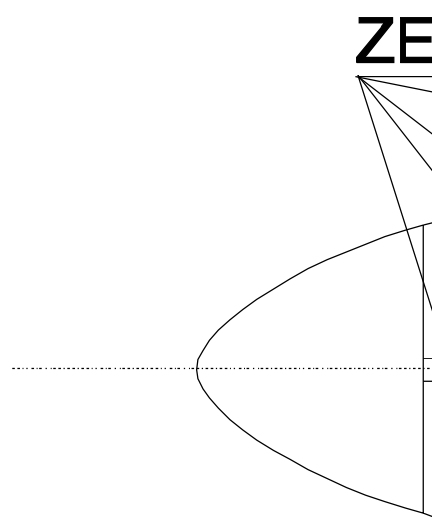
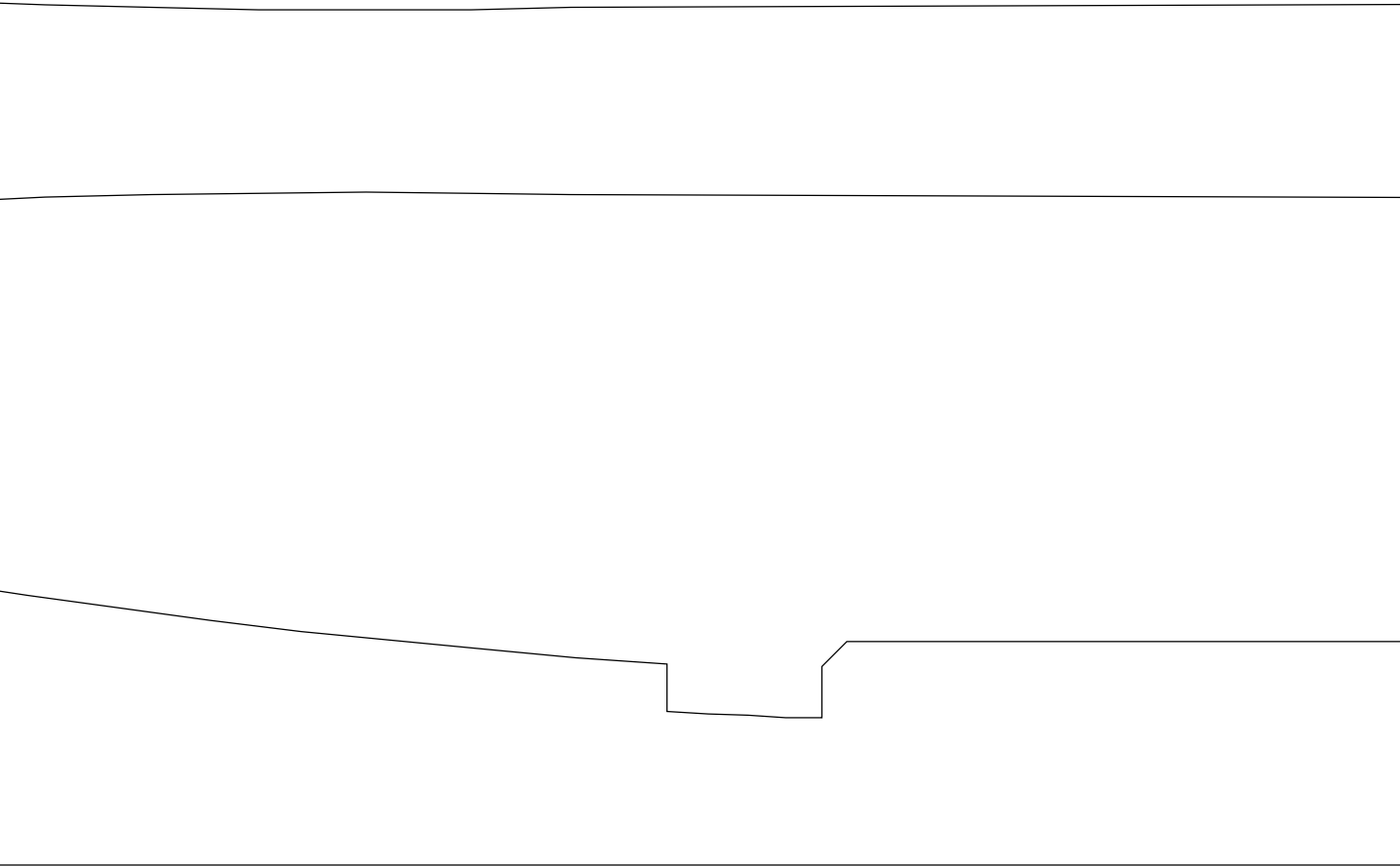

WYSZLIFOWAĆ DO OBRYSU

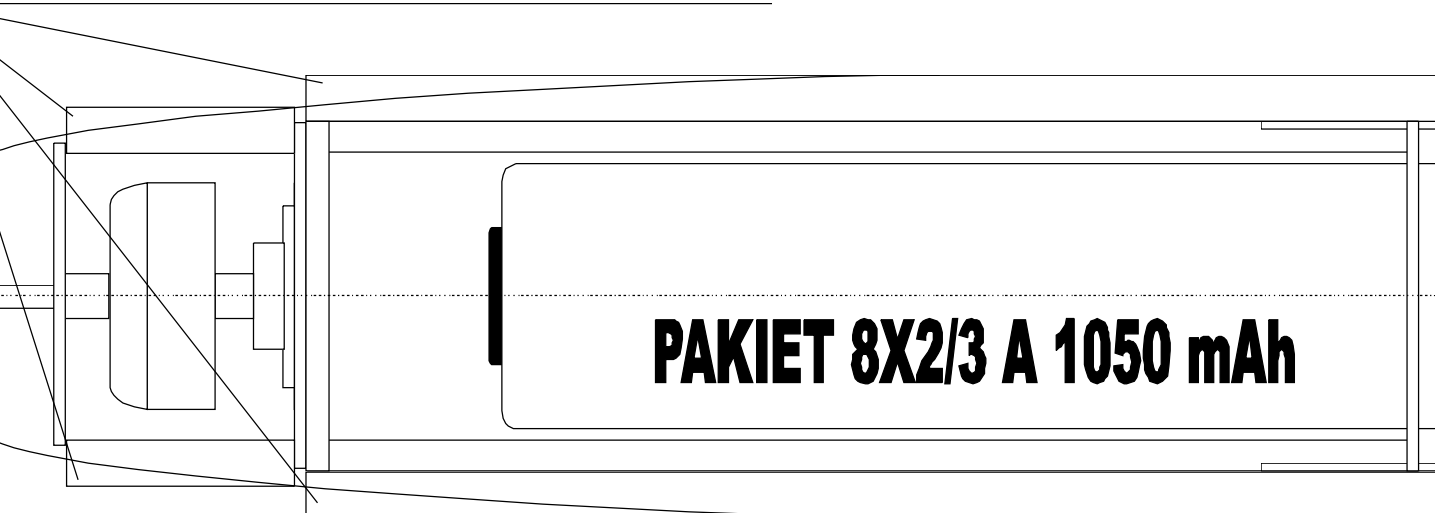

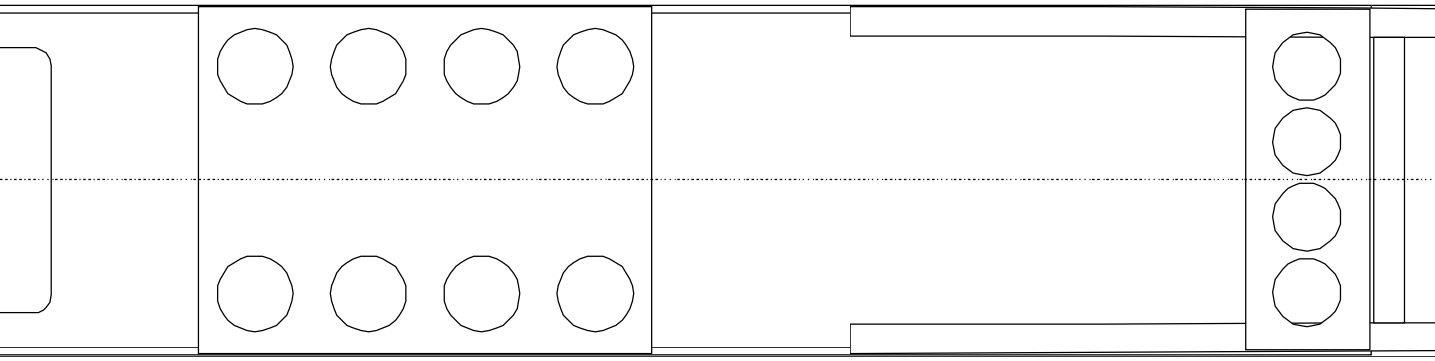

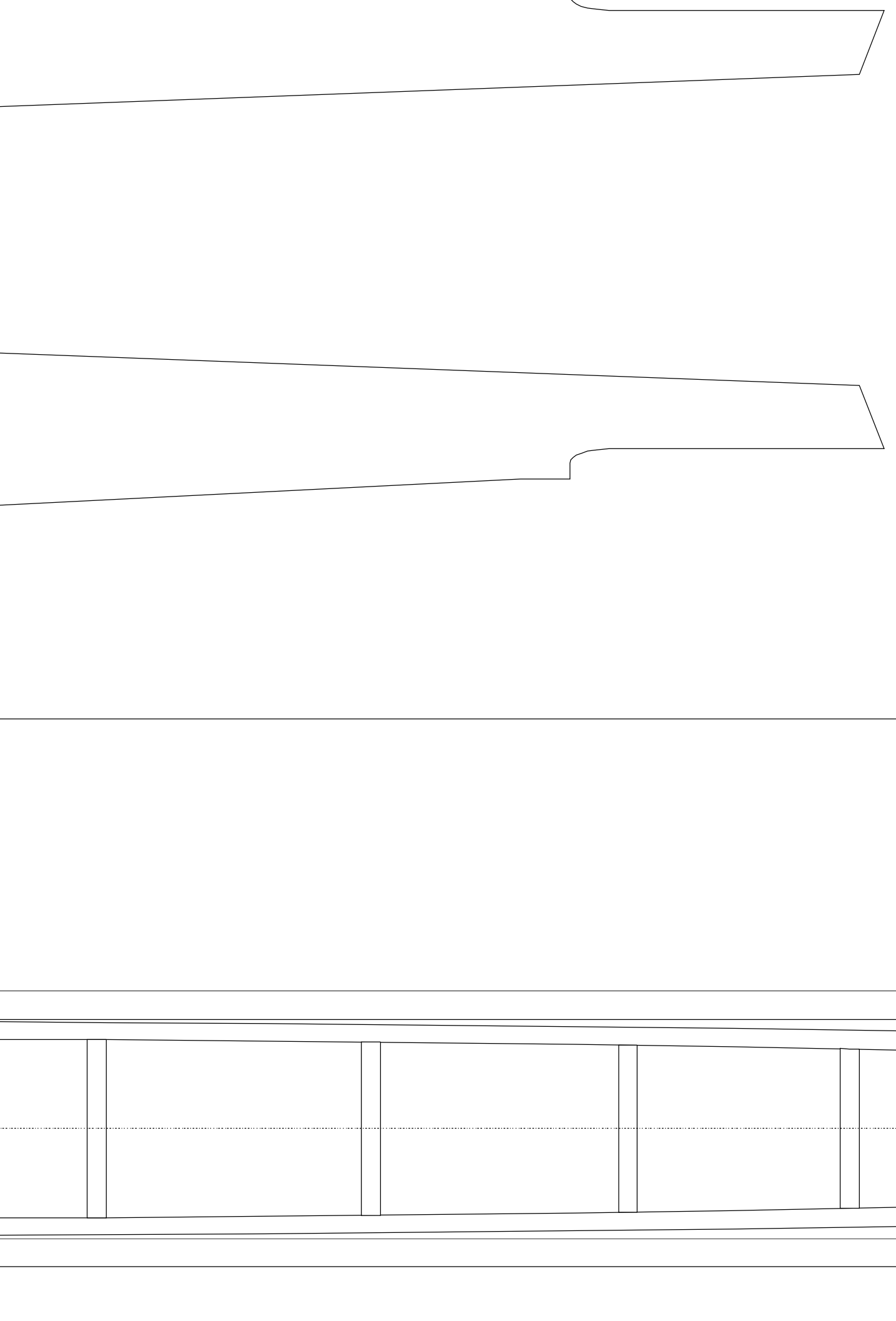

BOKI DOGIAĆ I DOKLEIĆ DO KRATOWNICY

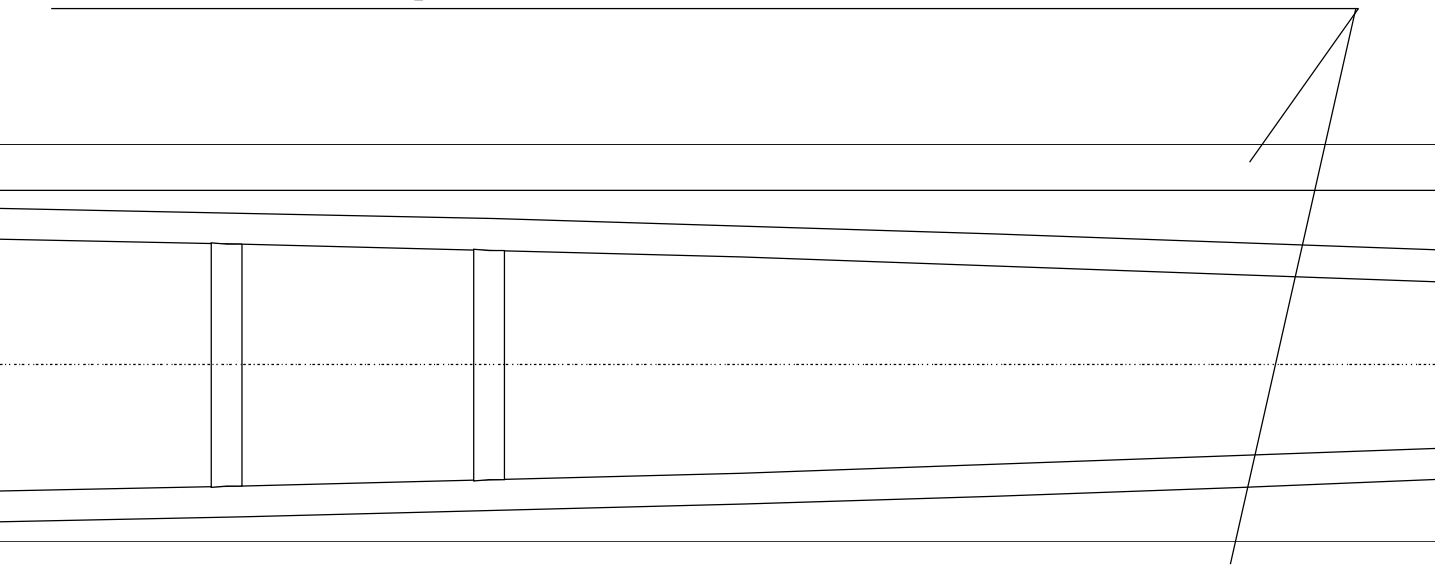

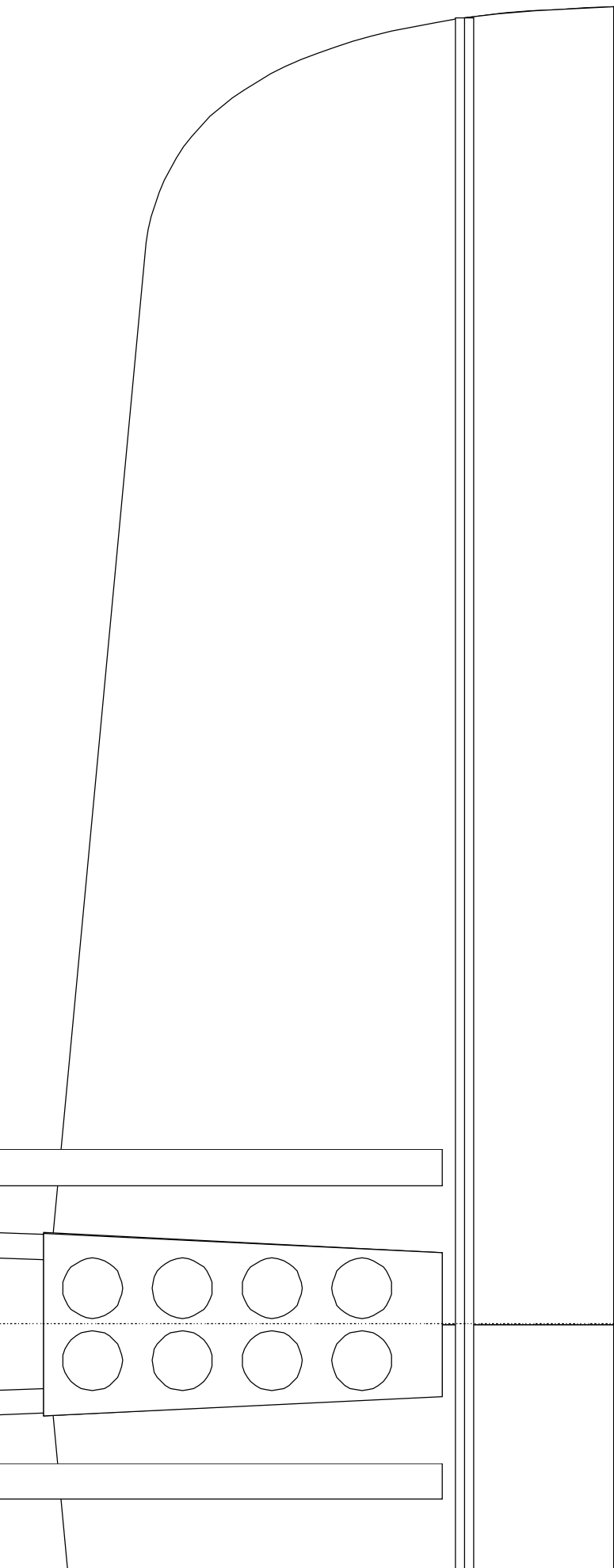

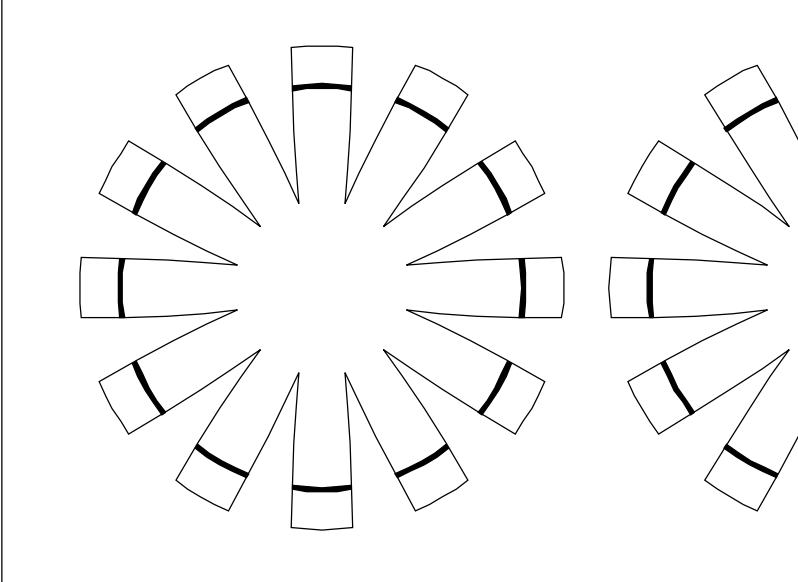

ŽEBERKA Z DEPRONU

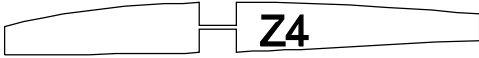
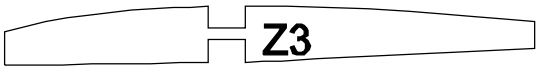
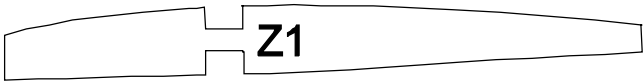

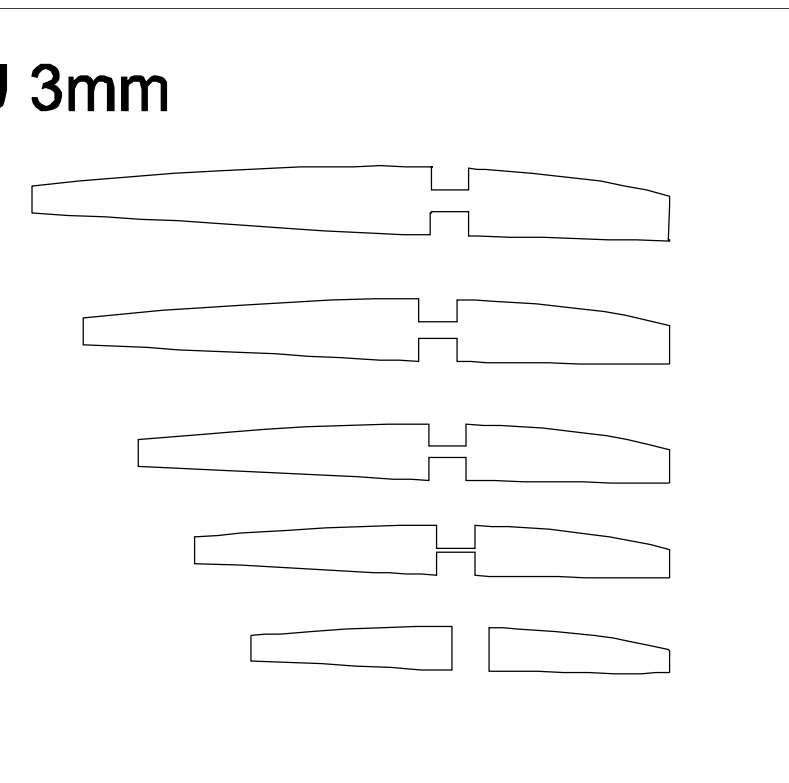
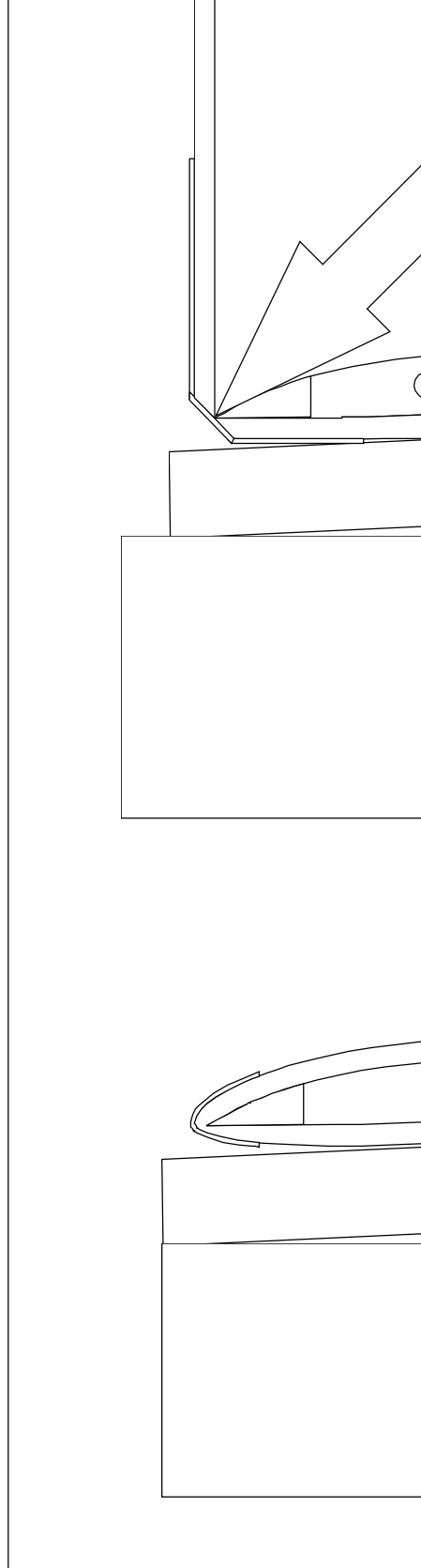
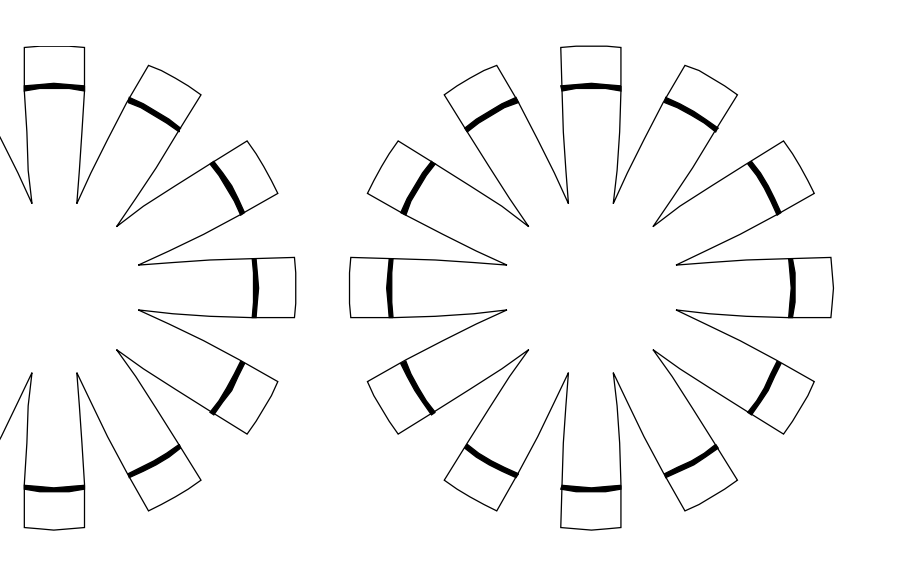

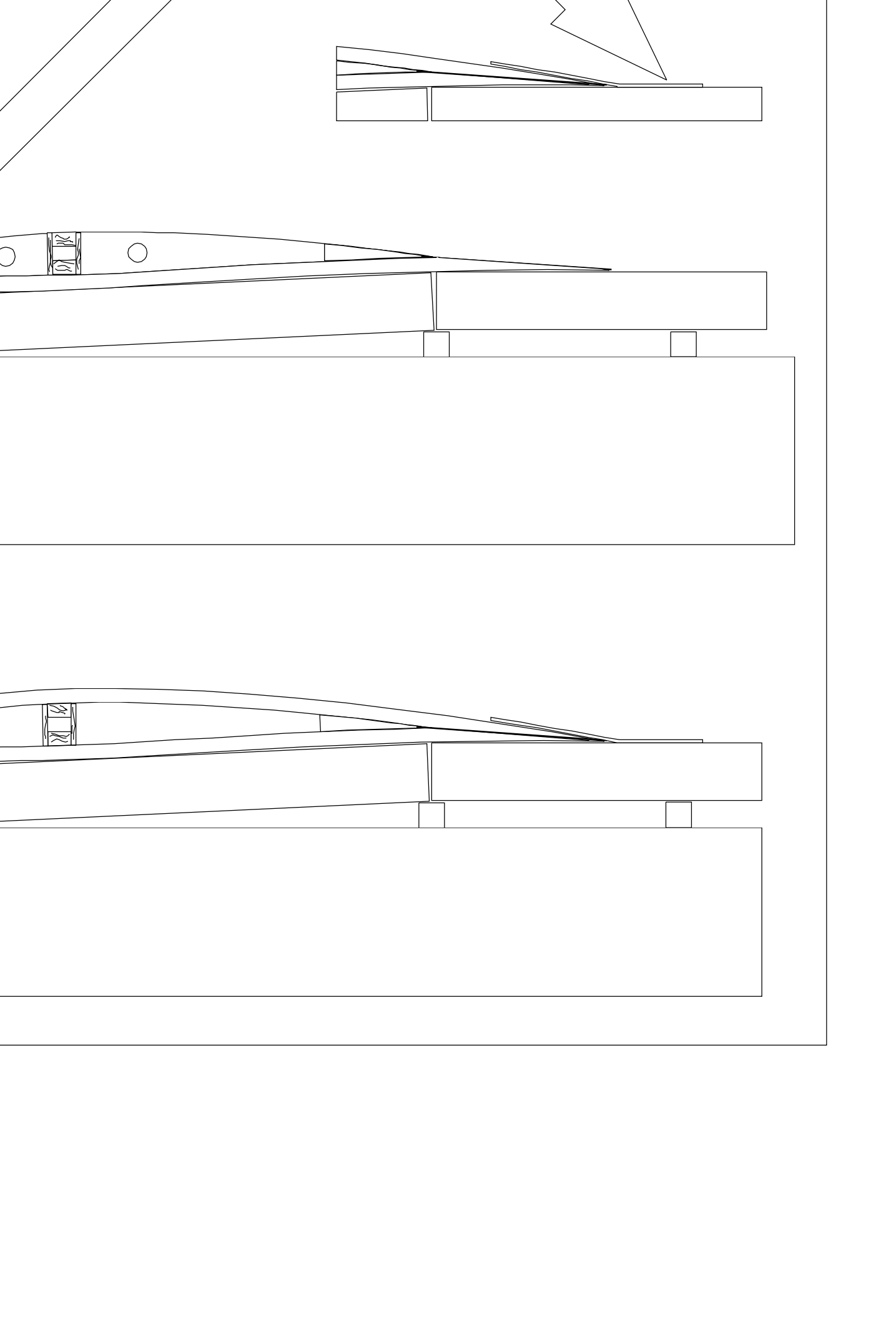

100 mm

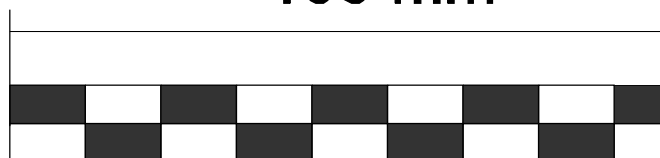

SKALA 1:1

Prezentowana konstrukcja jest własnością
Wszelkie inne użycie to

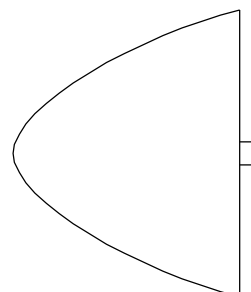

MOTOSZYBOWIEC DEPRO

Konstrukcja, opracowanie, kreślenie

Tomasz B. Motyl "Motylasty" - Tom

www.tbm.lasowice.net

email : tomaszbm@poczta.onet.pl

Własnością intelektualną autora, wykorzystywanie rysunków i informacji technicznych materiałów poza budową modelu dla własnych celów wymaga zgody

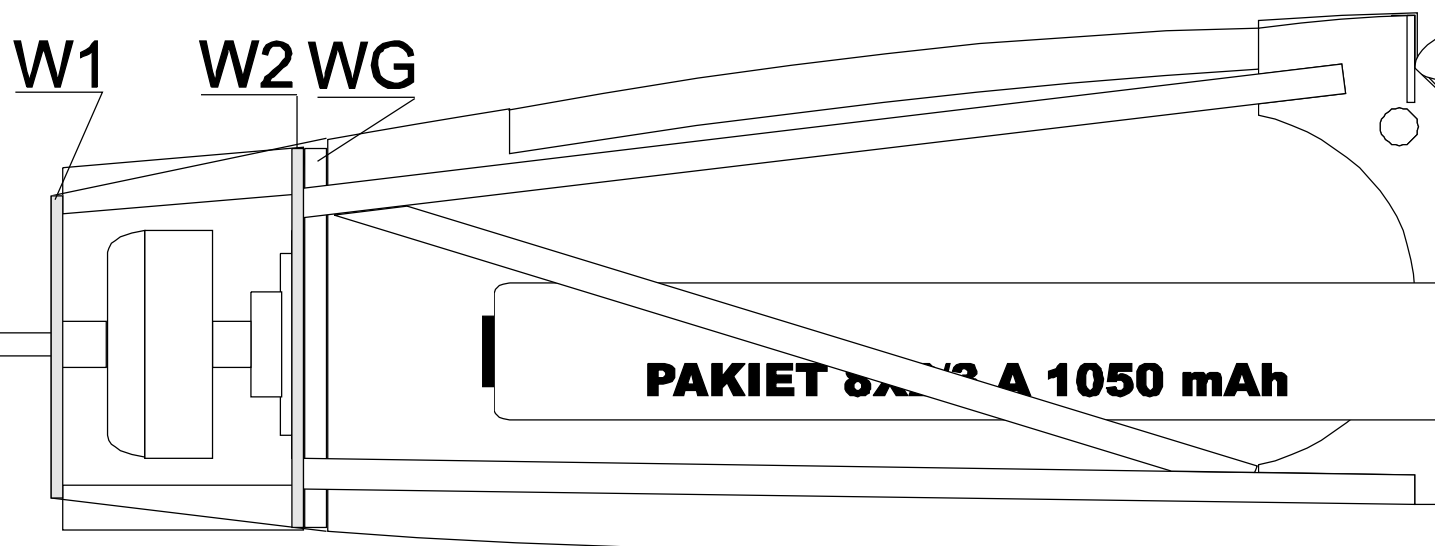

ONOWY RC- TOTO-2

ślenie :

Tarnowskie Góry 2007

t.pl

ji w celach komercyjnych jest ściśle zakazane.
uprzedniej pisemnej zgody autora.

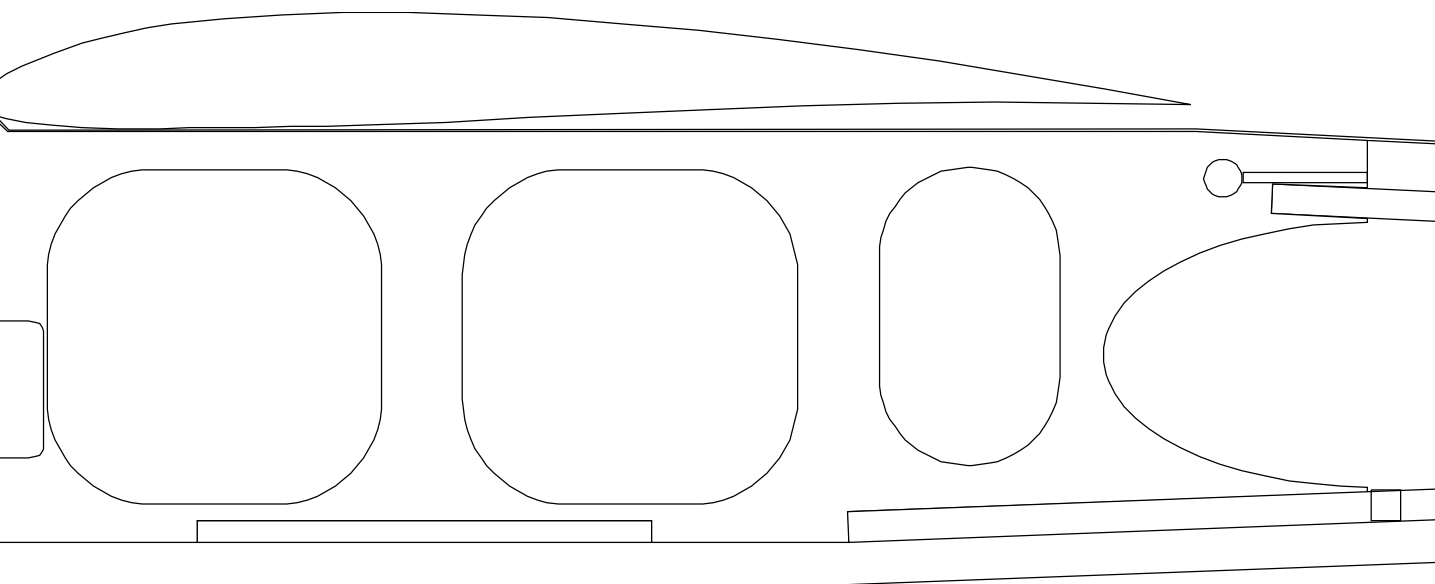

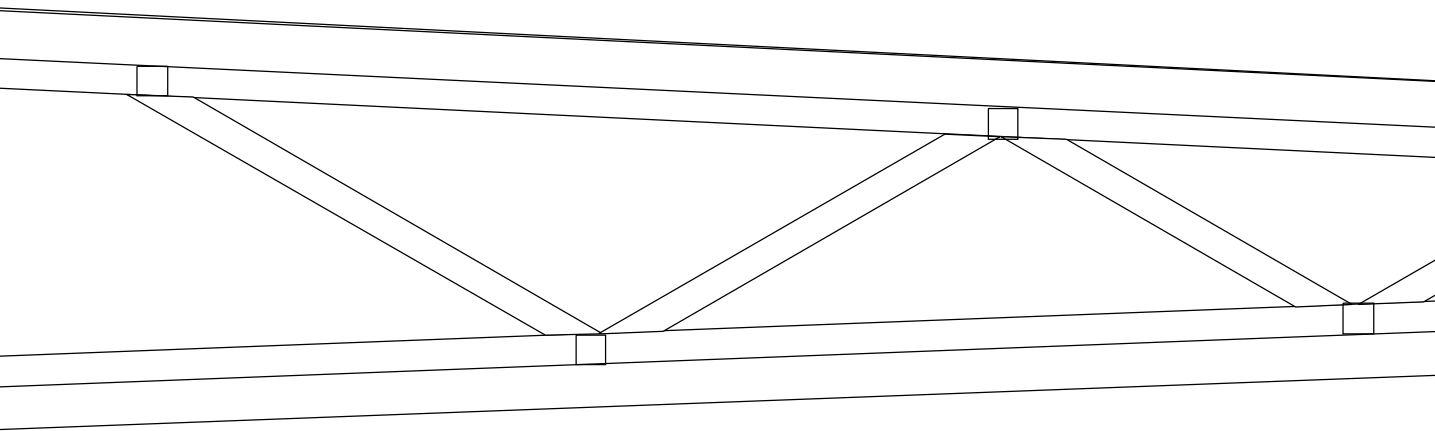

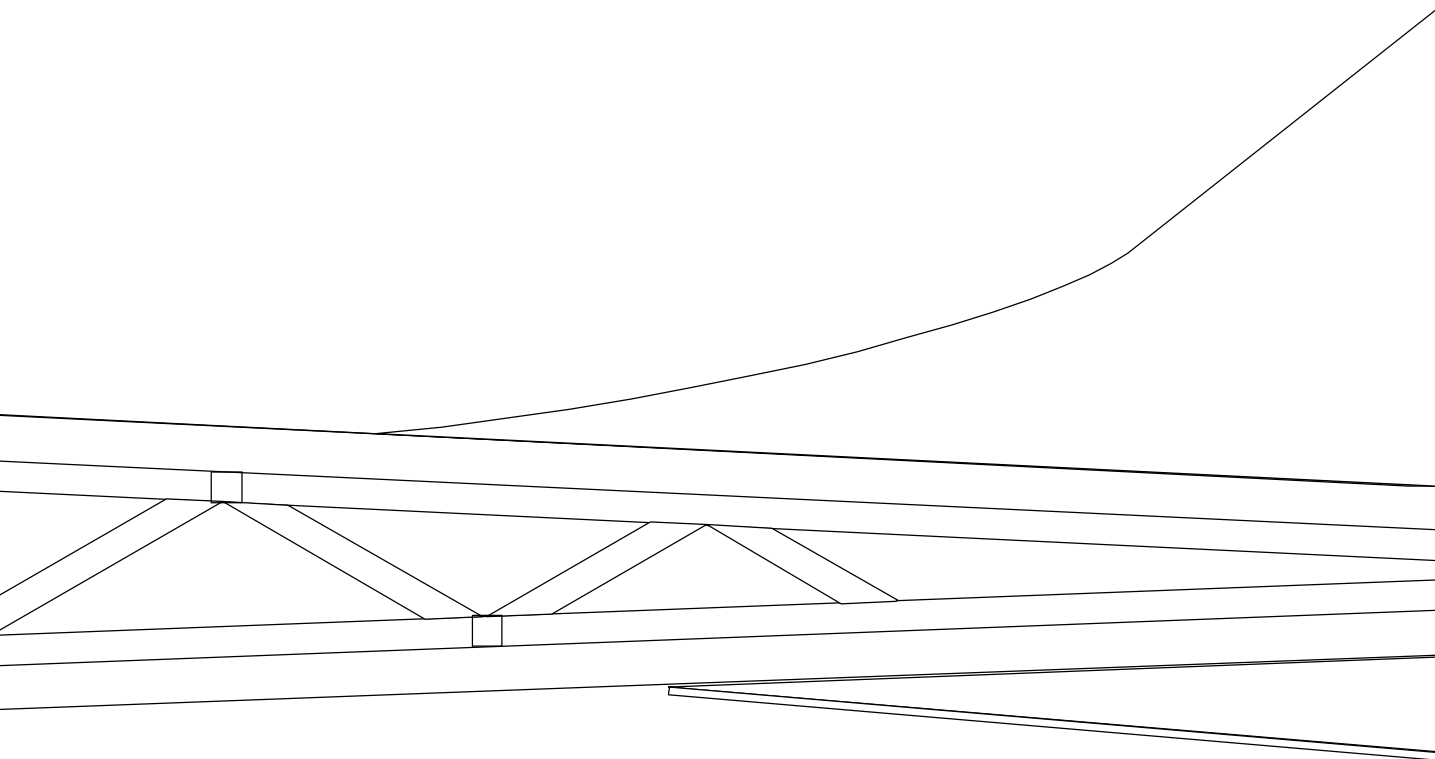

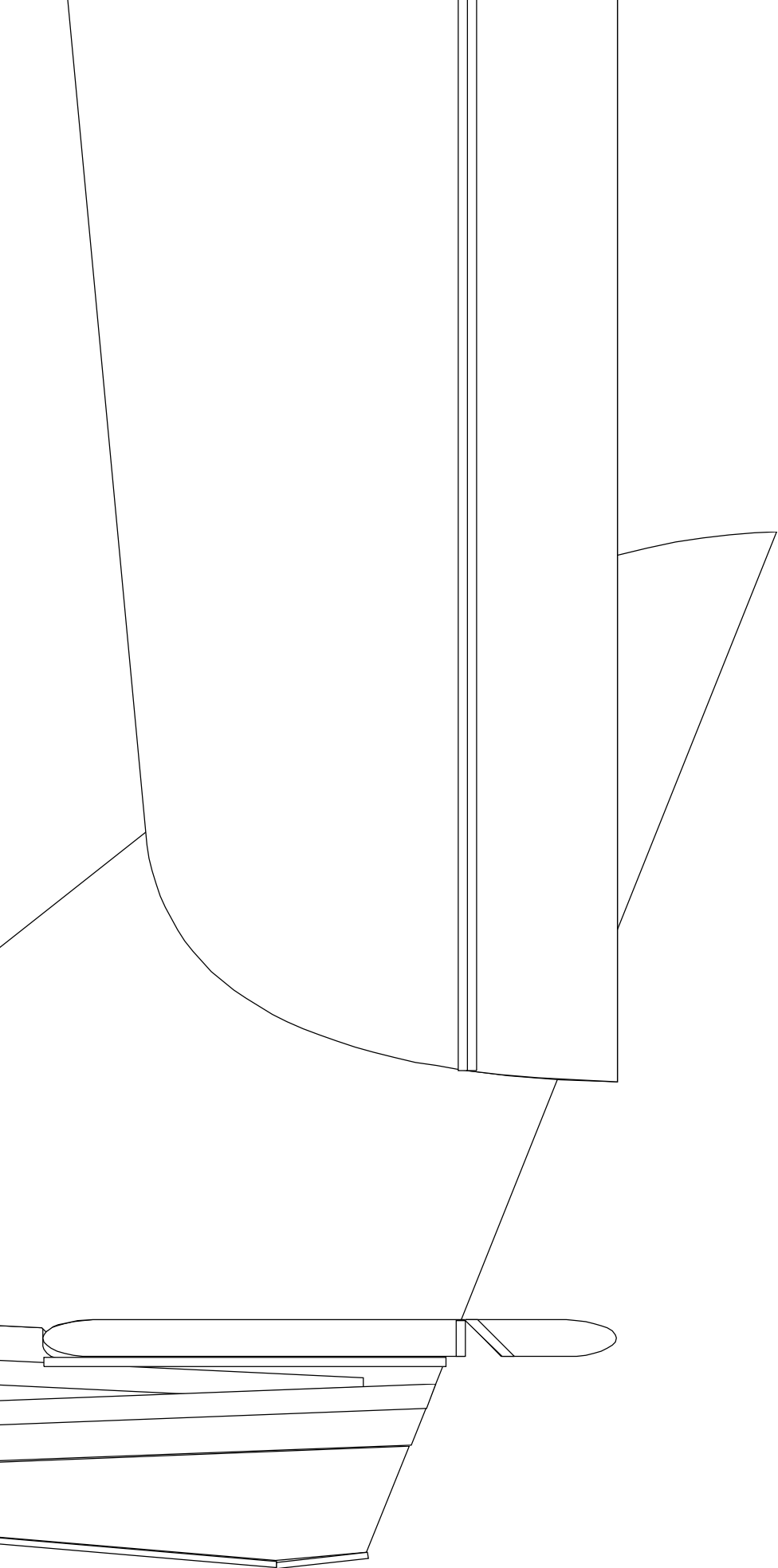

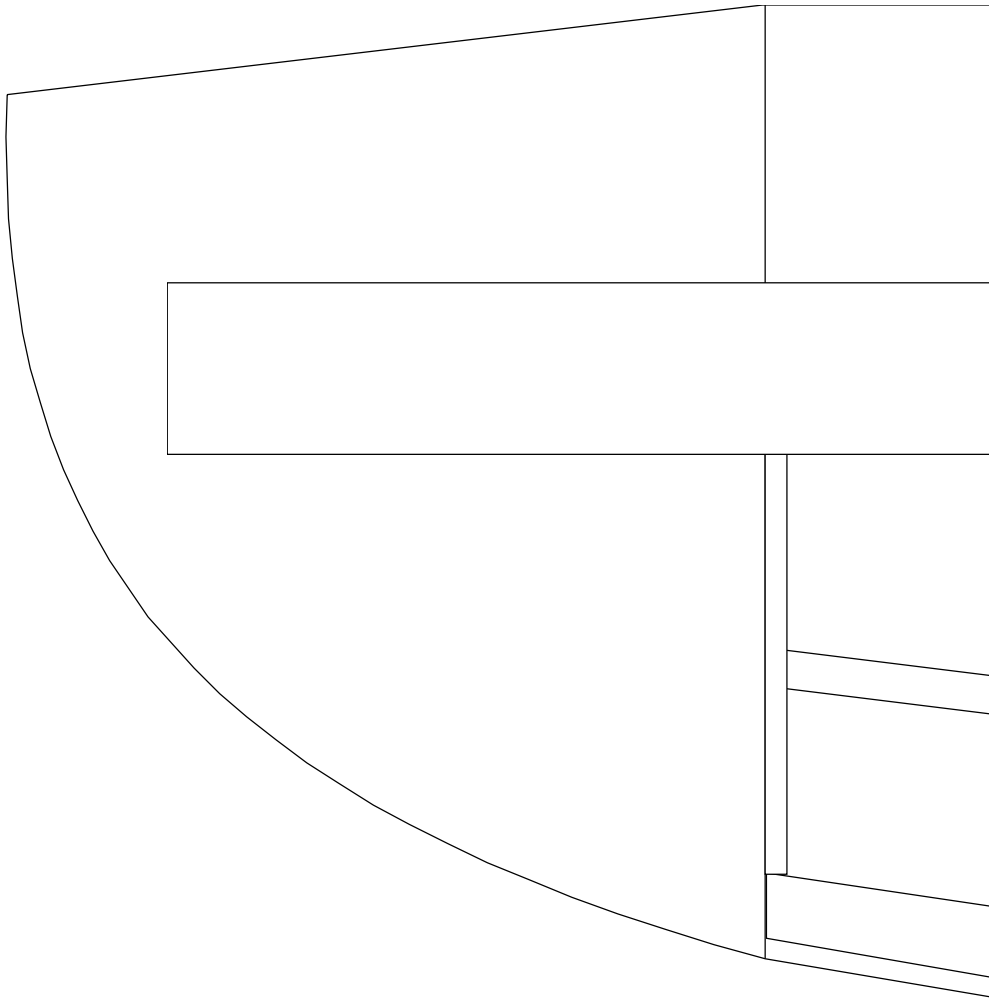

Z5

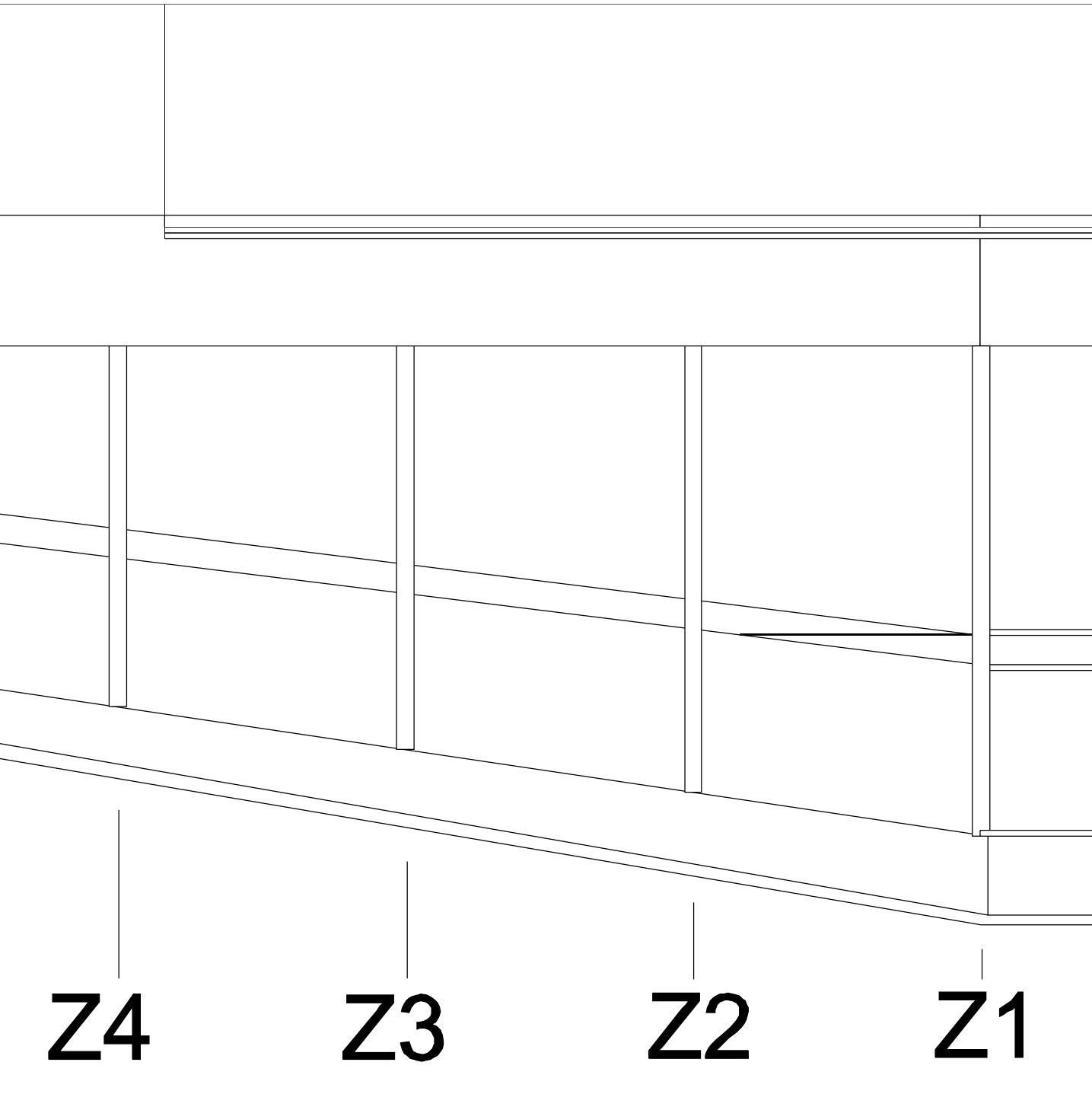

--	--	--	--	--

--	--	--	--	--

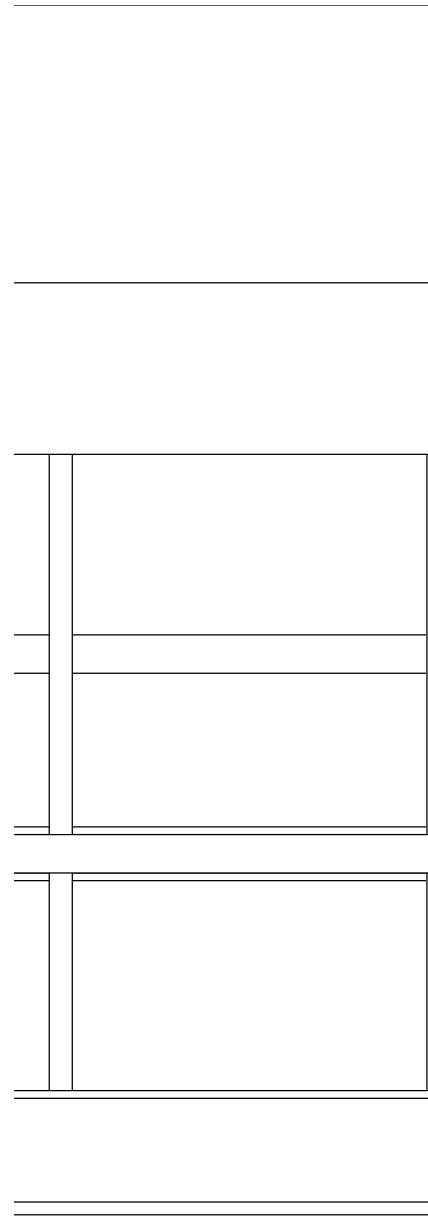
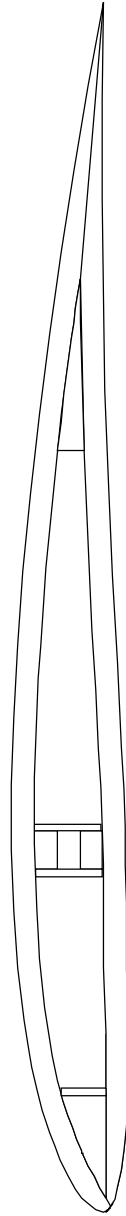
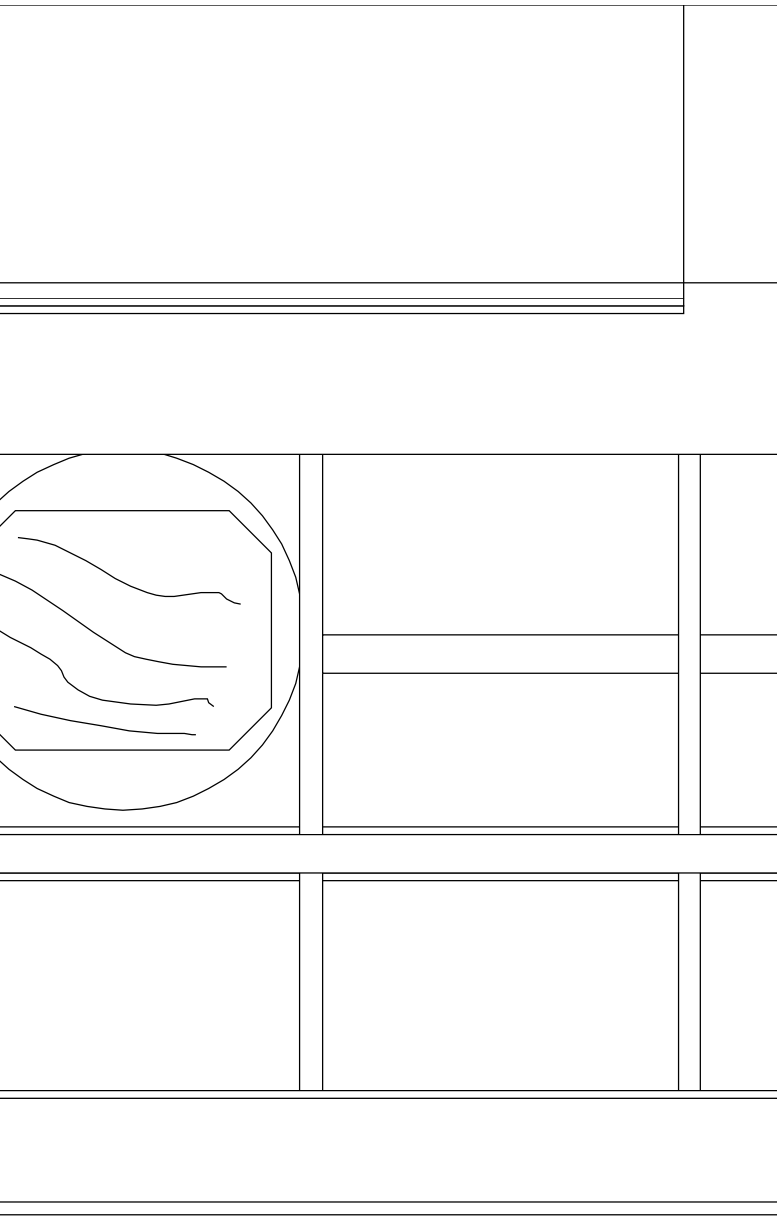

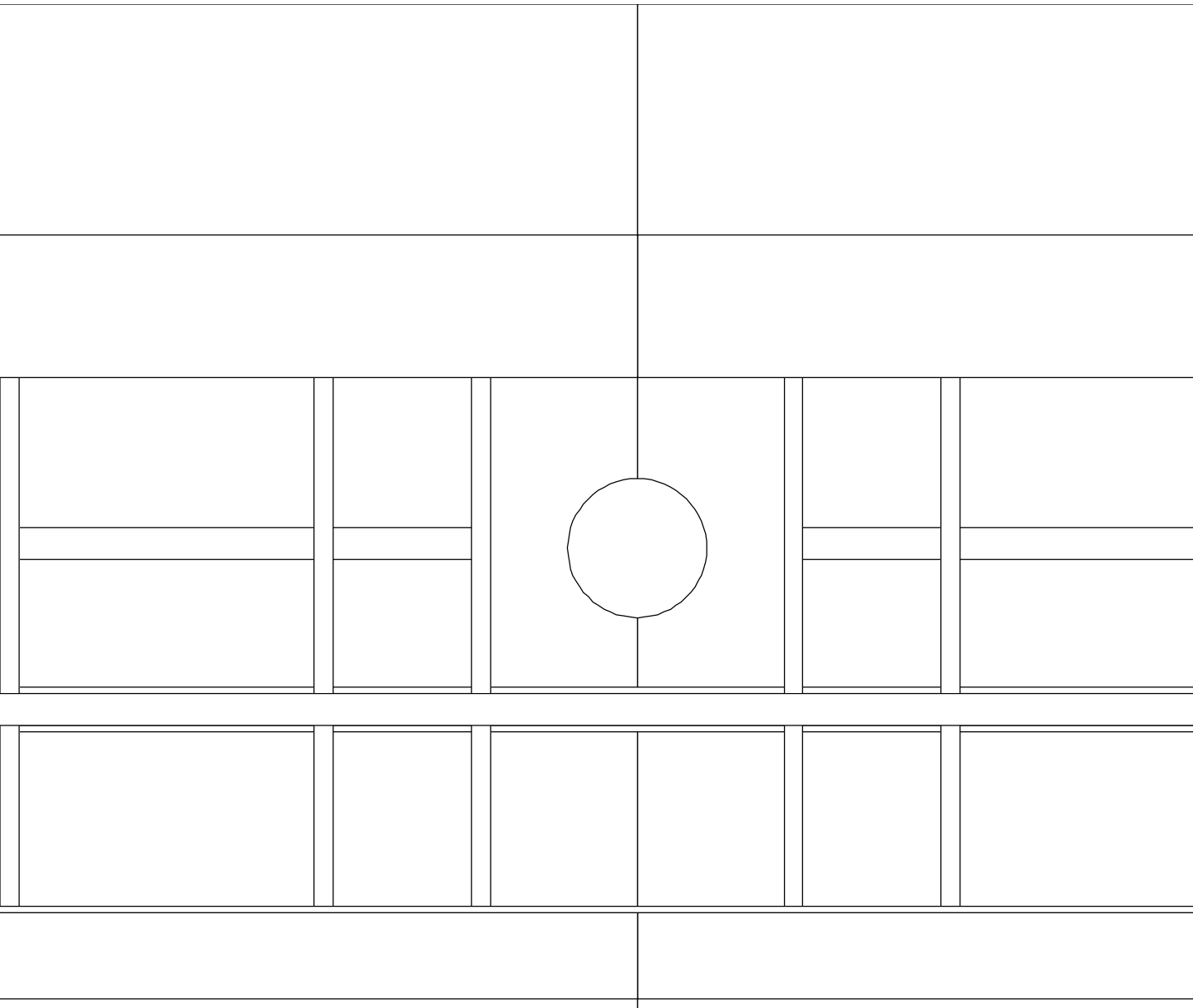

--	--

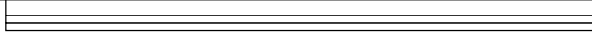

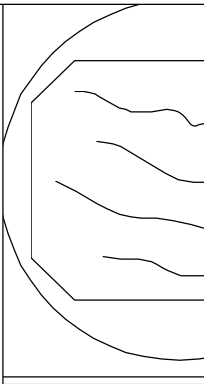
--	--	--	--	--

--

				
---	--	--	--	--

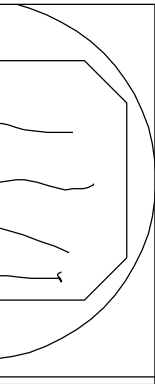
--	--	--	--	--

